



# Contents

<b>About this guide</b> .....	<b>3</b>
<b>What is an audio frequency induction loop system?</b> .....	<b>4</b>
<b>How does an induction loop system work?</b> .....	<b>5</b>
<b>Why we have induction loop systems</b> .....	<b>6</b>
<b>Where are ‘aids to communication’ required?</b> .....	<b>7</b>
<b>Which induction loop system should I use?</b> .....	<b>9</b>
1.2m <sup>2</sup> PL1 Portable Induction Loop System .....	10
1.2m <sup>2</sup> ML1/K Counter Induction Loop System .....	11
1.2m <sup>2</sup> PDA102C Counter Induction Loop System .....	12
1.2m <sup>2</sup> VL1 Vehicle Induction Loop System .....	13
50m <sup>2</sup> PDA102L/R/S Small Room Induction Loop System .....	14
50m <sup>2</sup> DL50/K Domestic Induction Loop System .....	15
120m <sup>2</sup> ‘AK’ Range Induction Loop Kits / PDA200E Amplifier .....	16
200m <sup>2</sup> PDA200/2 Professional Induction Loop Amplifier .....	17
500m <sup>2</sup> PDA500/2 Professional Induction Loop Amplifier .....	17
900m <sup>2</sup> PDA1000/2 Professional Induction Loop Amplifier .....	17
Microphones .....	18
Outreach Plates .....	19
Induction loop cable .....	21
<b>Induction loop system design and installation</b> .....	<b>22</b>
Maximum area coverage .....	22
Loop amplifier position .....	22
Loop cable position .....	22
Dead spots .....	23
Overspill .....	23
‘Low overspill’ reduced sized loops .....	24
‘Low overspill’ phase shifting loops .....	24
‘Low overspill’ fixed table loops .....	25
Mains hum .....	25
Interference .....	25
Damage to the loop .....	26
The ‘isolation’ issue .....	26
Vertical loops .....	26
In summary .....	26
<b>Testing an induction loop system</b> .....	<b>27</b>
<b>PDA range part numbers</b> .....	<b>29</b>

## About this guide

Induction loop systems are more properly termed AFILS, which stands for audio-frequency induction loop systems.

This guide - brought to you by the manufacturers of the PDA range of audio-frequency induction loop systems - aims to provide straightforward explanations of the technology involved together with hints, tips and advice on best practice installation.

In the UK, the installation of induction loop systems is governed by BS7594 (The Code of Practice for Audio-Frequency Induction Loop Systems) and EN60118-4 (Magnetic field strength in audio frequency induction loop systems for hearing aid purposes), copies of which are available from the British Standards Institute, 389 Chiswick High Road, London W4 4AL. Tel: +44 (0)20 8996 9000. Web: [www.bsi-global.com](http://www.bsi-global.com).

Other National standards of design, installation and commissioning should be referenced where pertinent.

## What is an audio-frequency induction loop system?

Audio-frequency induction loop systems allow hearing impaired people to hear more clearly. Most hearing aids have a 'T' or 'MT' switch which allows them to pick up the electromagnetic field generated by an induction loop system. The hearing aid converts this signal into a sound suited to its user's specific hearing requirements.

Any person with a hearing aid positioned within or near the loop can hear the loop signal by switching their hearing aid to the correct position, allowing them to participate more effectively in general conversation, ordering goods or services, listening to public performances, etc.

An induction loop system therefore comprises the following main elements:-

- ▶ **The audio source** - typically a microphone, television or radio (or a combination of these).
- ▶ **The induction loop amplifier**
- ▶ **The loop** - typically a single turn of wire usually run around the perimeter of the room or a special counter loop fixed to the underside of a table.
- ▶ **The receiver(s)** - any hearing aid with a 'T' or 'MT' switch or a specially designed loop listening device.

In addition to the many routine benefits for hearing aid users, induction loop systems can also be used for other limited area broadcasting applications such as museum 'walk through' guided tours and surveillance talkback systems.

### ***The main elements of an audio-frequency induction loop system***

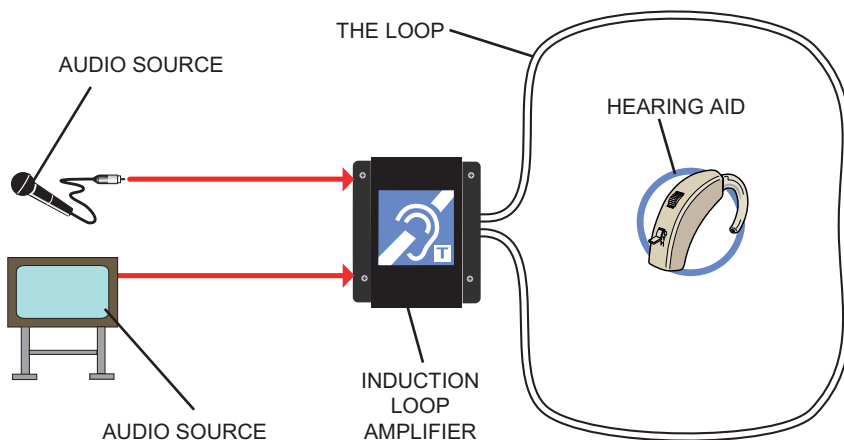

Some induction loop systems may require additional audio sources such as multiple microphone or line level inputs. To facilitate this, many PDA range amplifiers include an 'Outreach' socket which allows the connection of multiple inputs via a range of specially designed single gang audio connector plates. This system is described in detail on page 19.

## How does an induction loop system work?

Audio-frequency induction loop systems do not use radio frequencies; they operate at audio frequencies.

The signal from an audio source is fed into an induction loop amplifier, which amplifies and sets the signal level in the same way as a conventional amplifier. The amplified signal, instead of going to a loudspeaker, is fed to a closed loop of cable that is normally placed around the perimeter of the room. Employing a constant current amplifier ensures the current is maintained at the set level whilst providing a flat frequency response without the need for equalization circuitry.

The current flowing through the loop generates a magnetic field that radiates in the space around the loop cable (see diagram below). Any lines of magnetic flux that pass through the telecoil in a receiver, such as a hearing aid, will generate a current in the coil that is then converted back to audio and fed into the listener's ear.

It is important to remember that the magnetic field will 'bleed' outside the perimeter of the loop and therefore a loop system cannot be considered confidential. Ways of reducing this 'bleed' or 'overspill' are addressed on pages 24 and 25 of this guide.

### ***Magnetic field in a plane through one axis of a square loop***

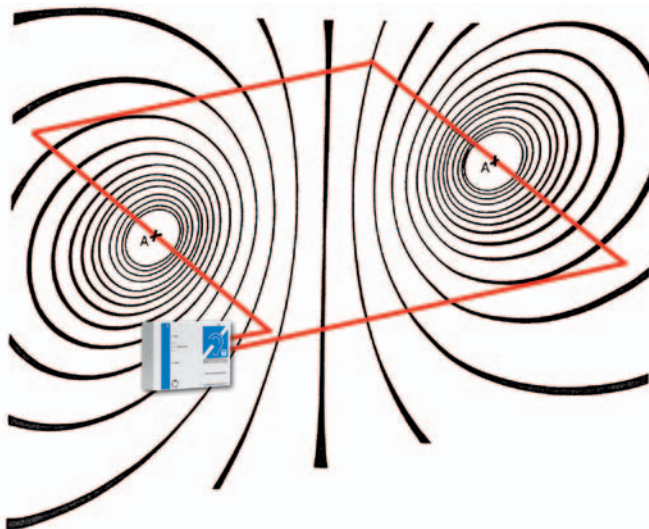

## Why we have induction loop systems

In normal use, hearing aids utilise a microphone for amplifying localised speech. Whilst this is effective for local conversations/quiet environments, it is less effective for listening to speech or music at a distance or in front of a security screen at a ticket counter. This is because the hearing aid's microphone also picks up any background noise in the room and unwanted speech from other conversations. An induction loop system works by moving the required sound closer to the hearing aid via the hearing aid's telecoil which is activated by turning it to the 'T' or 'MT' position.

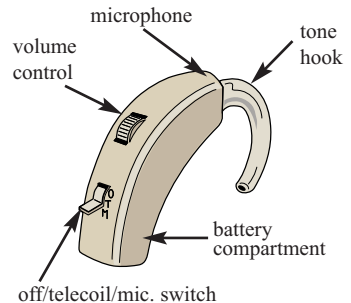

As telecoils are fitted as standard to most hearing aids (over 90% are said to have the 'T' position) induction loop systems can be considered cost-effective compared to other hearing assistance systems. Infrared systems, for example, require special receivers, the cost and maintenance of which must be met by the service provider.

Many modern hearing aids do not just amplify all frequencies equally; they are tailored to suit the user's hearing problem and amplify different bands by different amounts. This gives maximum intelligibility, so the user has the best chance of understanding what is said.

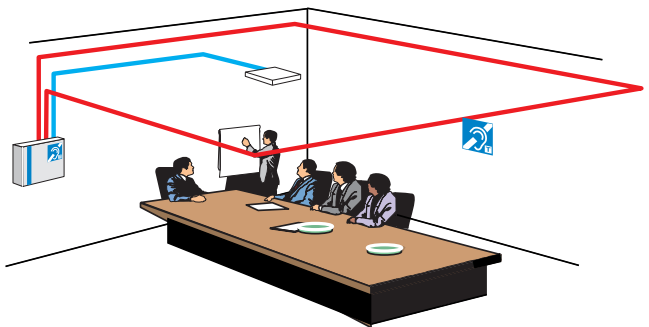

## In summary...

Induction loop systems are popular because:-

- ▶ Unwanted sounds such as other conversations and background noise are not picked up.
- ▶ No special receivers are required - telecoils are fitted as standard in most hearing aids or are an inexpensive option.
- ▶ Magnetic induction tends to be more reliable and effective than other systems (infrared, for example, is line of sight only).
- ▶ Modern hearing aids amplify different bands by different amounts to suit a user's specific hearing requirements.

## Where are 'aids to communication' required?

According to the the Royal National Institute for the Deaf (RNID):-

- Over 9 million people are deaf or hard of hearing (one in seven of the UK population)
- 2 million of these people have hearing aids
- 1.4 million people use hearing aids regularly
- 3 million people experience significant hearing difficulties

Lobbying by organisations such as the RNID has led to increased awareness of the difficulties faced by the hearing impaired, so much so that numerous Standards, Acts and Schemes now recommend the provision of auxiliary aids such as induction loop systems for the hard of hearing, as summarised below. These summaries refer to the published versions of the documents at the time of going to press. If in doubt, full copies of these documents can be purchased or viewed in their entirety from the organisations and/or websites indicated.

### BS 8300 (2002)



British Standard BS 8300 is the code of practice for the design of buildings and their approaches to meet the needs of disabled people.

The standard recommends that “a hearing enhancement system, using induction loop, infra-red or radio transmission, should be installed in rooms and spaces used for meetings, lectures, classes, performances, spectator sports or films, and used at service and reception counters where the background noise level is high or where glazed screens are used” (9.3.2). It pinpoints the following areas for consideration: seated

waiting areas; ticket sales and information points; fitness suites and exercise studios; churches; crematoria and cemetery chapels, educational, cultural and scientific buildings.

Copies of BS 8300 can be viewed at your local reference library or purchased from the British Standards Institute, 389 Chiswick High Road, London, W4 4AL. Tel: +44 (0)20 8996 9000. Web: [www.bsi-global.com](http://www.bsi-global.com)

### The Disability Discrimination Act (1995)

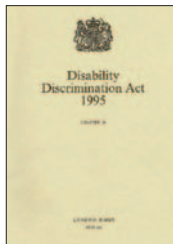

The aim of the DDA is to stop discrimination against disabled people including the hearing impaired. Under the Act, all UK service providers, i.e., organisations offering goods, facilities or services to the general public, must make 'reasonable' adjustments to ensure they do not unlawfully discriminate against disabled people. Employers must also take measures to ensure that employees are not disadvantaged in the workplace.

Examples of 'reasonable adjustments' include the provision of auxiliary aids, such as induction loop systems, to enable a hard of hearing person to access goods, facilities or services where it is impossible or unreasonably difficult for them to do so. The DDA was strengthened in 2004 when the Disability Rights Commission's (DRC) Code of Practice came into effect. The DRC is an independent body, established by Act of Parliament, which supports disabled people in getting their rights under the DDA and gives advice to disabled people, employers and service providers.

- For more information on the DDA, visit the DRC's website at [www.drc-gb.org](http://www.drc-gb.org)

## Building Regulations Part M1 : Access to and use of buildings (2000)



Current building regulations for England and Wales state that newly erected or substantially reconstructed non-domestic buildings should make reasonable provision for people to gain access to and use their facilities (Requirement M1). In particular, the regulations state that reasonable 'aids to communication' should be provided for the hearing impaired in auditoria, meeting rooms, reception areas, ticket offices and at information points. One of the aims of Requirement M1 is to ensure all people can participate in proceedings at lecture/conference facilities and entertainment, leisure and social venues. According to the regulations,

aids to communication will satisfy {part of} this requirement if 'a hearing enhancement system is installed in rooms and spaces designed for meetings, lectures, classes, performances ... and at service or reception counters when they are situated in noisy areas or behind glazed screens' (section 4.36/4.36b) The regulations acknowledge that a person with a hearing disability needs to receive a signal that is amplified in both volume and signal-to-noise ratio and that induction loop, infrared, radio and sound field systems can provide this advanced level of sound (section 4.35, Design Considerations).

- Building Regulations, Part M1 can be viewed at the website of the Office of the Deputy PM at [www.odpm.gov.uk](http://www.odpm.gov.uk)

## Care Standards Act (2002)



The Care Standards Act demands that care homes in England provide certain adaptations and equipment for residents, including:- 'facilities, including communication aids (e.g. a loop system), and signs to assist the needs of all service users, taking account of the needs, for example, of those with hearing impairment, visual impairment, dual sensory impairments, learning disabilities or dementia or other cognitive impairment, where necessary.' (standard 22.6). These requirements apply to all care homes providing accommodation and nursing or personal care for older people in England. Regular inspections and enforcement of the

legislation is carried out by the Commission for Social Care Inspection (CSCI)

- For more information on the Care Standards Act, visit the CSCI's website at [www.csci.org.uk](http://www.csci.org.uk)

## The English Tourism Council's National Accessible Scheme (2002)



This Scheme aims to increase accessibility for guests who are mobility, hearing and visually impaired. Participation in the scheme is not compulsory, but those who do are given recommendations which include the provision of auxiliary aids in serviced and self-catering accommodation to help satisfy the requirements of the DDA. 'Best practice' recommendations include the fitting of a counter or portable loop system to assist hearing impaired guests on booking/arrival and the installation of room loops in bedrooms. Other best practice recommendations are that consideration be given to providing a TV listening aid and room loop in television

lounges and that induction loops be 'part of the standard equipment' in conference, entertainment and banqueting areas.

- For more information, visit [www.tourismtrade.org.uk](http://www.tourismtrade.org.uk)

## Which induction loop system should I use?

The PDA range of induction loop equipment is one of the most comprehensive in the UK. It comprises a huge range of amplifiers, microphones, connector plates and test equipment covering virtually every conceivable AFILS application.

Before deciding which induction loop system to use, you first need to ascertain the size of the area to be covered in square metres (m<sup>2</sup>). Bear in mind it may not be necessary to cover the whole of the area, for example in a church only the pews may require coverage.

To calculate the size of the area in square metres, multiply the length by the width. For example, a room 6m x 6m in size would equal 36m<sup>2</sup>. The coverage provided by an AFILS amplifier is also quoted in square metres. The chart below, and information in the rest of this section, will help you select the best PDA Range product(s) for the job.

### Induction loop amplifier selection chart

PDA PRODUCT	SIZE OF AREA REQUIRING COVERAGE
PL1 portable loop kit ML1/K counter loop kit PDA102C counter loop kit VL1/B1 vehicle loop kit	Counters, desks, tables & other small areas up to 1.2m <sup>2</sup>
PDA102L/R/S small room kits DL50/K domestic loop kit	Rooms up to 49m <sup>2</sup> (7 x 7m)
AK RANGE loop kits PDA200E amplifier	Rooms up to 120m <sup>2</sup> (11 x 11m)
PDA200/2 professional loop amplifier	Rooms up to 200m <sup>2</sup> (14 x 14m)
PDA500/2 professional loop amplifier	Rooms up to 500m <sup>2</sup> (22 x 22m)
PDA1000/2 professional loop amplifier	Rooms up to 900m <sup>2</sup> (30 x 30m)

Designed to meet or exceed the requirements of BS7594 and EN60118-4 when correctly installed, all of the amplifiers in the PDA range offer excellent intelligibility, true current mode amplification, phantom power (for electret microphones) and full compatibility with the 'outreach plate' audio input extension system (except the PL1, VL1 and DL50). Many are also available in kit format for ease of specification, purchase and installation.

The entire PDA range is explained in detail over the coming pages.

## 1.2m<sup>2</sup> PL1 portable induction loop system

- ▶ Ideal for restricted person to person contact in areas such as banks, post offices, small meeting rooms, reception desks, open plan offices and ticket booths
- ▶ Portable, lightweight design means the system can be moved easily from location to location
- ▶ Simple one button operation
- ▶ Integral high performance microphone
- ▶ Five years' expected battery life under normal operating/charging conditions
- ▶ Auto shut-off facility (user selectable for 10, 30 or 60 minutes) helps preserve battery life
- ▶ Unit can be used as normal whilst charging



 Typical PL1/K1 meeting room application

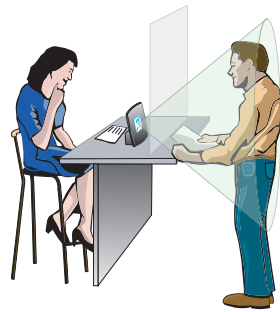

 Typical PL1/K1 counter/ticket booth application

### at a glance...

<b>TYPE</b>	Portable
<b>COVERAGE</b>	1.2m <sup>2</sup> approx.
<b>DIMENSIONS</b>	W 250 x D 300 x H 100mm (main unit); 1.7Kg
<b>INPUTS</b>	2 x Mic (one built-in mic. and one 3.5mm remote mic. socket for AMT or AMD mics)
<b>INDICATORS</b>	Power on; input level; charging required; charging in progress, audio warning of imminent shutdown.
<b>CONTROLS</b>	On/off button; adjust auto-shut off timer
<b>KIT VARIANTS</b>	<p>PL1/K1 : PL1 amplifier, plugtop charger, 'AFILS available' sticker, cardboard carry case.</p> <p>PL1/K2 : PL1 amplifier, plugtop charger, FoSmeter H magnetic field strength meter/loop listening device; headphones, 'AFILS available' sticker, cardboard carry case</p> <p>PL1/K3 : As PL1/K1 but in a robust plastic storage/carry case</p> <p>PL1/K4 : As PL1/K2 but in a robust plastic storage/carry case</p>

## 1.2m<sup>2</sup> ML1/K double gang fixed counter induction loop system

- ▶ Ideal for banks, post offices, small meeting rooms, reception desks, ticket booths and any other application requiring restricted or small area coverage
- ▶ Requires no specialist audio experience or connectors - can be fitted by any competent electrician
- ▶ Space-saving double-gang wall-mounting amplifier fits standard UK 25mm back boxes (requires fixed mains wiring).
- ▶ Omni-directional AMT microphone (supplied) plugs directly into 3.5mm socket on the amplifier's front
- ▶ Line/outreach socket also provided (max 3 outreach plates per system)
- ▶ User-adjustable mic. sensitivity and engineer-adjustable loop drive and input level controls

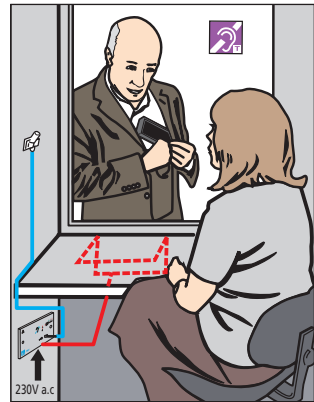

▶  
**Typical ML1/K  
 counter/ticket booth  
 application**

### at a glance...

<b>TYPE</b>	Wall mounting (requires fixed mains wiring and a 25mm back box)
<b>COVERAGE</b>	1.2m <sup>2</sup> approx.
<b>DIMENSIONS</b>	W 143 x H 83 x D 32mm; 300g (amplifier only)
<b>INPUTS</b>	1 x 3.5mm remote mic. socket; 1 x Line/Outreach socket
<b>INDICATORS</b>	Input level; power on; loop drive meter.
<b>CONTROLS</b>	Mic. input level, line input level; loop drive
<b>KIT CONTENT</b>	ML1 amplifier; AMT microphone; TX2 pre-formed counter loop; 'AFILS fitted' sticker.

## 1.2m<sup>2</sup> PDA102C free-standing counter induction loop system

- ▶ Ideal for banks, post offices, small meeting rooms, reception desks, ticket booths and any other application requiring restricted or small area coverage
- ▶ Includes a 3.5mm microphone input (for use with the AMT microphone supplied) and a line/outreach socket
- ▶ Adjustable drive control allows the amplifier's output stage to be set-up to suit the exact characteristics of any room
- ▶ State-of-the-art audio processor features an automatic gain control which compensates for poor microphone techniques and helps suppress loud noises, hisses and clicks
- ▶ Designed to be free-standing or wall-mounted using the keyholes provided

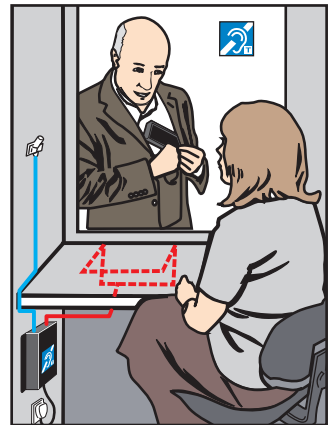

▲  
Typical PDA102C counter/ticket booth application

### at a glance...

<b>TYPE</b>	Free-standing/wall mountable. Plugtop mains lead supplied.
<b>COVERAGE</b>	1.2m <sup>2</sup> approx.
<b>DIMENSIONS</b>	W 136 x H 56 x D 178mm (amplifier only); 1.25Kg
<b>INPUTS</b>	1 x 3.5mm remote mic. socket; 1 x Line/Outreach socket
<b>INDICATORS</b>	Input level; loop current; power on
<b>CONTROLS</b>	Combined input level; loop drive
<b>KIT CONTENT</b>	PDA102 amplifier; AMT microphone; TX121 pre-formed counter loop; 'AFILS fitted' sticker

## 1.2m<sup>2</sup> VL1/B1 12V vehicle induction loop system

- ▶ Ideal for cars, taxis, buses and other private/commercial vehicles
- ▶ Kit includes a compact mini-induction loop amplifier (pictured right) with keyholes for dashboard mounting, a cigarette lighter power adaptor, an AMT microphone, a pre-formed loop and an 'AFILS fitted' sticker
- ▶ Amplifier operates at 12V d.c. (24V vehicle kit also available, order code VL1/B2)
- ▶ Loop can be positioned in the vehicle's roof lining, under a seat, across the back of a seat or in a door panel to suit the application
- ▶ Metal compensation control helps combat the frequency response problems caused by metal 'absorbing' the magnetic field
- ▶ Optional VL9 lead available for connection to the vehicle's audio system



### at a glance...

<b>TYPE</b>	Dash mounting; 12V
<b>COVERAGE</b>	1.2m <sup>2</sup> approx.
<b>DIMENSIONS</b>	W 120 x H 31 x D 60mm; 220g.
<b>INPUTS</b>	1 x 3.5mm remote mic. socket; 1 x line
<b>INDICATORS</b>	Input level, loop current, power on
<b>CONTROLS</b>	Mic level; Line level, loop drive, metal compensation
<b>KIT VARIANTS</b>	VL1/B1: VL1 Amplifier; TX2 Pre-formed loop; AMT microphone; AL8 Fused cigarette lighter power adaptor; 'AFILS fitted' sticker
	VL1/B2 : VL1 Amplifier; TX2 Pre-formed loop; AMT microphone; VL1PSU24 24V to 12V converter; AL7 2.5mm DC power plug to bare end lead; 'AFILS fitted' sticker.

## 50m<sup>2</sup> PDA102L/R/S small room induction loop systems

- ▶ Three variants available
- ▶ PDA102L ideal for use in small meeting rooms, council chambers, doctor surgeries, etc.
- ▶ PDA102R ideal for small room applications where equipment needs be mounted above suspended ceilings, etc.
- ▶ PDA102S ideal for use in nursing home TV lounges
- ▶ Includes a 3.5mm microphone input and line/outreach socket
- ▶ Designed to be free-standing or wall-mounted using the keyholes provided

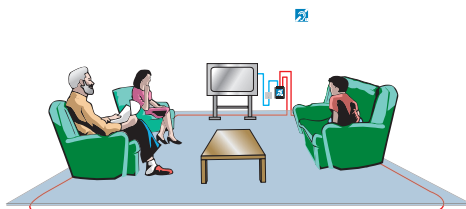

Typical PDA102S TV lounge application

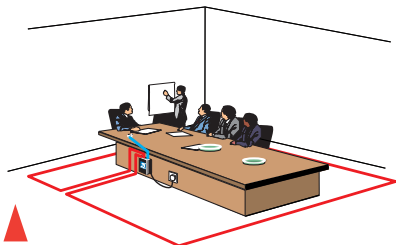

Typical PDA102L meeting room application

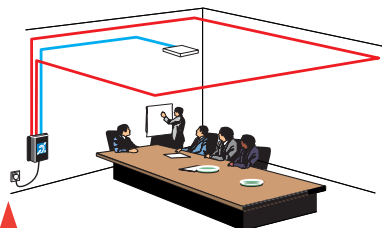

Typical PDA102R meeting room application

Note that the APM plated microphone supplied in the PDA102R kit provides direct speech coverage of 2.5m so in larger rooms you may need to fit more.

### at a glance...

<b>TYPE</b>	Free-standing/wall mountable. Plugtop mains lead supplied.
<b>COVERAGE</b>	50m <sup>2</sup> approx.
<b>DIMENSIONS</b>	W 136 x H 56 x D 178mm (amplifier only); 1.25Kg
<b>INPUTS</b>	1 x 3.5mm remote mic. socket; 1 x Line/Outreach socket
<b>INDICATORS</b>	Input level; loop current; power on
<b>CONTROLS</b>	Combined input level; loop drive
<b>KIT VARIANTS</b>	PDA102L: PDA102 amplifier; AMT tie/desk microphone; 30m loop cable; 'AFILS fitted' sticker
	PDA102R: PDA102 amplifier; APM plated microphone; 30m loop cable; 'AFILS fitted' sticker.
	PDA102S: PDA102 amplifier; APL dual phono outreach plate, APS Scart lead; 30m loop cable; 'AFILS fitted' sticker

## 50m<sup>2</sup> DL50/K domestic induction loop system

- ▶ Free-standing - ideal for bedrooms, living rooms, TV lounges, studies and other domestic applications
- ▶ Simple to adjust, tamper-resistant drive, level, tone and mic. priority controls
- ▶ Input peak, output current, signal present and power on LEDs
- ▶ Alert tone input for doorbells, fire alarms, security systems, etc.

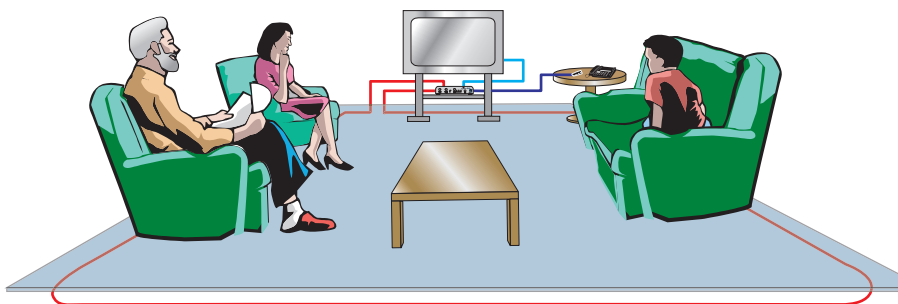

Typical DL50/K domestic TV lounge application

### at a glance...

<b>TYPE</b>	Free standing, Plugtop mains lead supplied.
<b>COVERAGE</b>	50m <sup>2</sup> approx.
<b>DIMENSIONS</b>	W 185 x H 40 x D 85mm (amplifier only); 550g
<b>INPUTS</b>	2 x 3.5mm microphone sockets, 1 x dual phono (line) socket, 1 x alert
<b>INDICATORS</b>	Input level; loop current meter; power on
<b>CONTROLS</b>	Input level, loop drive, tone, microphone priority
<b>KIT CONTENT</b>	DL50 amplifier, plug-top power supply, 33m of loop cable, SCART-to-double-phono lead, AMT microphone, 'AFILS fitted' sticker

## 120m<sup>2</sup> AK Range induction loop amplifiers and kits

- ▶ Available in a wide range of kit formats - suitable for use in meeting rooms, waiting rooms, TV lounges, health and fitness suites, churches, etc (see kit list below)
- ▶ PDA200E amplifier includes straightforward internal screw connectors
- ▶ Wall-mounting metal enclosure for permanent installation
- ▶ Internal drive, level and tone controls

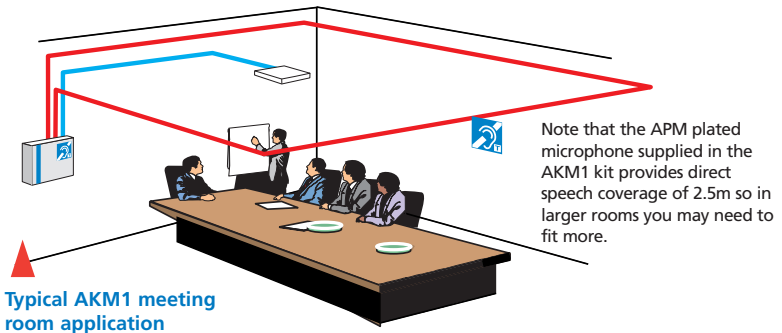

### at a glance...

<b>TYPE</b>	Wall mounting, requires fixed mains wiring
<b>COVERAGE</b>	120m <sup>2</sup> approx.
<b>DIMENSIONS</b>	W 271 x H 200 x D 77mm (amplifier only); 2.82kg
<b>INPUTS</b>	1 x Microphone, 1 x Line/Outreach, 1 x Alert and 1 x 100V line (all screw type connectors)
<b>INDICATORS</b>	Input level; loop drive meter; power on
<b>CONTROLS</b>	Input level, loop drive, tone
<b>KIT VARIANTS</b>	<p><b>AKM1 Meeting room kit:</b> PDA200E amplifier; APM plated mic.; 'AFILS fitted' sticker</p> <p><b>AKR1 Waiting room kit:</b> PDA200E amplifier; APL outreach plate (paging system input); 'AFILS fitted' sticker</p> <p><b>AKT1 TV / music lounge kit:</b> PDA200E amplifier; AMH handheld mic.; APS scart lead; APJ outreach plate; APL outreach plate; 'AFILS fitted' sticker.</p> <p><b>AKL1 Lecture room kit:</b> PDA200E amplifier; AMT tie/desk mic.; AML lectern mic.; 2 x APJ outreach plates; 'AFILS fitted' sticker.</p> <p><b>AKU1 Retail unit kit:</b> PDA200E amplifier; AML lectern mic.; APJ outreach plate; 'AFILS fitted' sticker.</p> <p><b>AKW1 Place of worship kit 1:</b> PDA200E amplifier; AML lectern mic.; APJ outreach plate; APL outreach plate (audio input for CD/tape deck); 'AFILS fitted' sticker.</p> <p><b>AKW2/L Place of worship kit 2 (lavalier version):</b> PDA200E amplifier; AMR/LA lavalier radio mic; APQM outreach plate, 2 x APXM outreach plates (for existing mics.); 'AFILS fitted' sticker.</p> <p><b>AKW2/H Place of worship kit 2:</b> as AKW2/L but with a handheld radio mic.instead of a lavalier mic.</p> <p><b>AKH1/L Health &amp; fitness club kit (lavalier mic. version):</b> PDA200E amplifier; AMR/LA lavalier radio mic; APQM outreach plate, APL outreach plate (for CD/tape deck); 'AFILS fitted' sticker.</p> <p><b>AKH1/H Health &amp; fitness club kit:</b> as AKW1/L but with a handheld radio mic.instead of a lavalier mic.</p>

## 200m<sup>2</sup> to 900m<sup>2</sup> PDA Pro-range induction loop amplifiers

- ▶ Ideal for theatres, cinemas, churches, conference halls and other applications where top quality sound is a must
- ▶ Each unit includes two XLR 3-pin input sockets (one balanced mic. and one switchable balanced mic./line) and one outreach connector.
- ▶ Adjustable level controls provided for all inputs - can be used individually or together as a three-input mixer
- ▶ Metal compensation control helps offset the frequency response problems associated with excessive metal in a building
- ▶ Includes a true output current meter and provides visual indication of the amplifier's compressor action via two LEDs
- ▶ 3.5mm headphone socket allows true monitoring of the output signal
- ▶ Advanced audio signal processing with automatic gain control

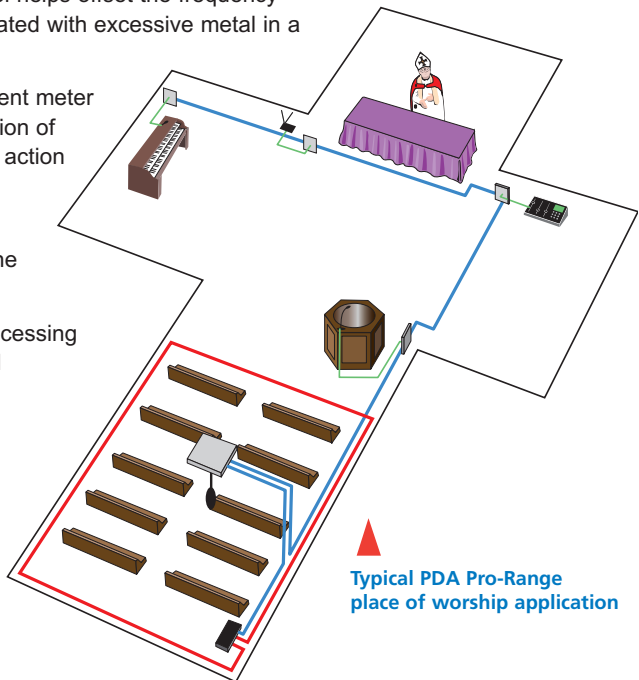

### at a glance...

<b>TYPE</b>	Free-standing (optional wall or 2U 19" rack mount kits available); plugtop IEC mains lead provided
<b>COVERAGE</b>	200m <sup>2</sup> (PDA200/2); 500m <sup>2</sup> (PDA500/2); 900m <sup>2</sup> (PDA1000/2)
<b>DIMENSIONS</b>	W 380 x H 80 (2U) x D 220mm; 3.74kg (PDA200/2), 3.46kg (PDA500/2); 4.54Kg (PDA1000/2)
<b>INPUTS</b>	2 x XLR (one mic.; one mic./line) and one outreach connector
<b>INDICATORS</b>	Loop drive meter; compression (high/low); power on
<b>CONTROLS</b>	3 x input level controls, loop drive, metal compensation, on/off switch

## Microphones

Electret microphones have the highest tolerance of magnetic feedback and are therefore recommended for induction loop systems. Dynamic microphones should not be used as they contain moving coil magnets which can be affected by the magnetic field generated by the loop.

Phantom power is provided on all PDA range amplifiers, so electret microphones with internal batteries are not necessary.

When deciding which electret microphone to use, the following guide should prove useful.

APPLICATION / MICROPHONE TYPE	MODEL NO.
Conference table (centre of tabletop, counter, etc)	AMT tie/desk mic
	APM plated mic
	AMH handheld mic + stand
	AMP* professional handheld mic + stand
Lectern (for pulpits, lectures, etc)	AML fixed gooseneck mic, long stem
	AMLS fixed gooseneck mic, short stem
	AMD movable gooseneck mic, long stem
	AMDS movable gooseneck mic, short stem
Lavalier (for the lapel of an after dinner speaker)	AMT tie/desk mic
	AMR/LA, B or C (radio mic)
Ambient mic (for audience response etc)	APM at distances of $\leq 2.5\text{m}$
	PRO45 at distances $\geq 2.5\text{m}$
Ceiling (recessed in the ceiling above a table)	APM at distances of $\leq 2.5\text{m}$
	PRO45 at distances $\geq 2.5\text{m}$
Desk Microphone with Push To Talk (PTT)	AMD/P (as AMD with PTT)
Handheld	AMH handheld mic
	AMP* professional handheld mic
	AMR/HA, B or C (radio mic)

\* All PDA range microphones are supplied with a connection lead apart from the AMP. If using an AMP, a range of connection leads are available, contact our sales desk for details.

To avoid interference, microphone cables should be sited at least one metre away from loop cable.

## The Outreach Plate audio input extension system

The Outreach Plate audio input extension system comprises a range of wall, ceiling and desk mountable single gang audio input plates specifically designed to increase the audio input capability of an induction loop system.

Covering the most common variants of audio connector, they work by mixing the signals from various audio input sources into one balanced line level input which can be fed into the line input of a compatible amplifier.

Mountable on 25mm single gang back boxes, each plate features a built-in mixer, pre-amp, input level control and balanced output. The fact they can be installed at the most convenient point on an installation overcomes the need for excessively long and potentially hazardous microphone/audio leads.

Typically, up to 10\* Outreach plates (any mix) can be daisy-chained to one balanced line level input with cable lengths of up to 100m easily achievable using standard two-pair audio cable with no recognisable degradation of audio signal quality.

Each outreach plate requires four wires, two balanced line (A +, A -), one ground (0V) and one power connection (12-32 V DC regulated). To facilitate their straightforward connection, most PDA Range amplifiers are fitted with an Outreach connection socket as standard.

### Example wiring to equipment fitted with an 'Outreach' socket

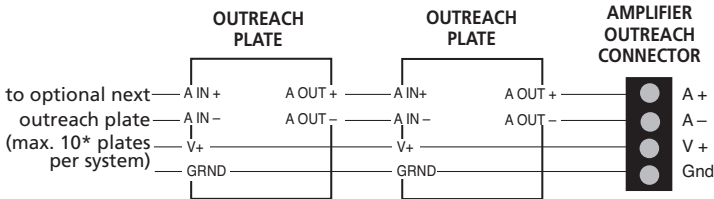

If you wish to connect Outreach plates to an audio system that has a line level input but not a 12-32V auxiliary output, an external 24V 250mA d.c. regulated power supply (part no. APV) can be used, as detailed below:

### Example wiring to equipment that does not have a 12-32V d.c. output

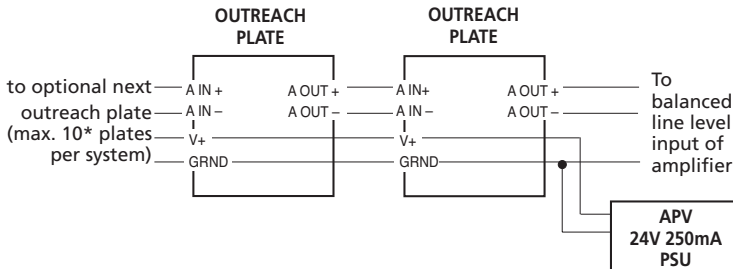

\* Only 3 Outreach plates can be connected to ML1 amplifiers.

## Outreach plate variants

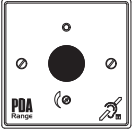

### APM OMNI-DIRECTIONAL PLATED MICROPHONE

A self-contained omni-directional electret microphone complete with onboard mic to line level converter. Typical coverage up to 25m<sup>2</sup> (ambient) or 2.5m (direct speech) when located at a ceiling height of 2.5-3m.

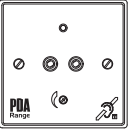

### APL DUAL PHONO LINE LEVEL PLATE

Accepts stereo phono line-level signals (usually from a stereo source such as a TV). Includes an on-board stereo phono to mono converter. (An APS SCART to dual phono lead is also available).

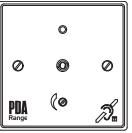

### APJ 3.5mm MICROPHONE JACK PLATE

Accepts unbalanced electret microphones with 3.5mm mono jack plugs. Includes an onboard mic to line level converter, high gain pre-amplifier and 8V phantom power.



### APQM 6.35mm (1/4") MICROPHONE JACK PLATE

Accepts balanced or unbalanced electret microphones with 6.35mm (1/4") jack plugs. Includes an on-board mic to line level converter, high gain pre-amplifier and 8V phantom power.



### APXM XLR 3 PIN MICROPHONE PLATE

Accepts balanced or unbalanced microphones with standard 3 pin XLR connectors. Includes an on-board mic to line level converter, high gain pre-amplifier and 8V phantom power.

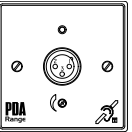

### APXL XLR 3 PIN LINE LEVEL PLATE

Accepts standard 3 pin XLR feeds from audio equipment such as stage or church mixing desks, etc.

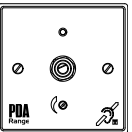

### APQL 6.35mm (1/4") LINE LEVEL PLATE

Accepts 6.35mm (1/4") jack feeds from audio equipment such as stage or church mixing desks, etc.

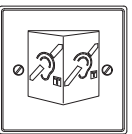

### API 'AFILS ACTIVE' PLATE

Includes two ultra-bright LEDs in a translucent diffuser overprinted with the AFILS 'ear' symbol. The LEDs illuminate when the Outreach network is powered to indicate that an AFILS system is installed.

Also available: The APSS phase shifter, see page 24 for details.

## Induction loop cable

There is nothing electrically special about induction loop cable. Almost any stranded or solid single core cable with tough insulation can be used, provided it is not liable to break (to minimise the chance of it shorting to earth and damaging the amplifier's output) and is of the appropriate gauge and DC resistance (0.5 to 1 Ohm).

If purchasing a PDA range induction loop kit, always use the loop cable supplied with the kit. If purchasing an amplifier that does not include loop cable, refer to the loop cable selection chart below.

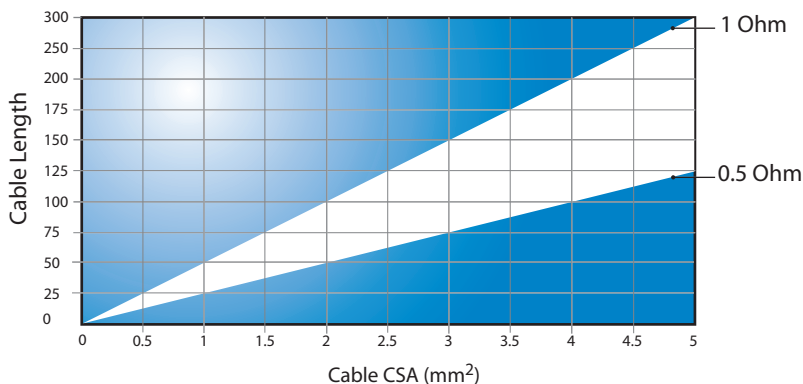

The chart shows the recommended CSA (cross-sectional area) for different lengths of loop cable. Simply work out the length of the loop required and choose a cable size that falls into the non-shaded area of the graph. For example, to cover a room 30m x 20m (600m<sup>2</sup>) the loop cable would need to be 100m long (2 sides @ 30m and 2 sides @ 20m). The recommended cable CSA for a loop this length is between 2mm<sup>2</sup> and 4mm<sup>2</sup>. Therefore, a PDA1000/2 (which can cover areas up to 900m<sup>2</sup>) using 2.5mm<sup>2</sup> cable would be sufficient.

The following loop cable is available from your PDA range distributor, all in 100m reels:-

- ▶ 0.5mm<sup>2</sup> white single core cable (LOOP1/W)
- ▶ 1.0mm<sup>2</sup> white single core cable (LOOP2/W)
- ▶ 1.5mm<sup>2</sup> white single core cable (LOOP3/W)
- ▶ 2.5mm<sup>2</sup> white single core cable (LOOP4/W)
- ▶ 0.5mm<sup>2</sup> black single core cable (LOOP1/B)
- ▶ 1.0mm<sup>2</sup> black single core cable (LOOP2/B)
- ▶ 1.5mm<sup>2</sup> black single core cable (LOOP3/B)
- ▶ 2.5mm<sup>2</sup> black single core cable (LOOP4/B)

Note that flat copper foil tape is also available and some installers prefer to use this as a floor loop under light duty carpets. Three sizes are available with cross sections of 0.5 mm<sup>2</sup> (part no. FLAT1005), 1.0mm<sup>2</sup> (part no. FLAT2005) and 1.5mm<sup>2</sup> (part no. FLAT3005). Protective tape will also be required to hold the cable down and reduce the likelihood of damage. Copper foil tape should be connected to the loop amplifier using solder or 1A 'choc' block.

Note that the chemical elements of some self-levelling floor compounds can react with the plastic covering of copper foil tape. If installing the loop under self levelling compound, we recommend you check their compatibility by covering a small piece of the tape with the compound to be used and look for any adverse reaction.

## Induction loop system design and installation

Induction loop system design and installation can be simple provided that a few basic facts are understood.

### Maximum area coverage

The approximate coverage provided by an AFILS amplifier is usually quoted in metres squared ( $m^2$ ). For example, the  $120m^2$  quoted for our PDA200E amplifier means that the PDA200E can cover rooms up to  $11 \times 11m$  in size. The PDA range has amplifiers that can cover everything from a  $1.2m^2$  ticket counter to a large  $900m^2$  conference hall.

Note that in certain installations, it may not be necessary to cover the whole room, i.e., in a bowling alley the loop may only need to cover the top of the lanes.

### Loop amplifier position

Induction loop amplifiers are best sited adjacent to the loop, as the feed cable will generate a magnetic field that may interfere with other areas. However, if a long feed cable cannot be avoided, the cable should be twisted to reduce magnetic radiation.

### Loop cable position

Under current IEEE wiring regulations (17th Edition), loop cable is classified as class 2A and, as such, must be sited at least 600mm away from telephone, mains and control cables.

In most installations, loop cable is usually run around the perimeter (edge) of the room.

The field strength in the plane of the loop (the height at which the cable is positioned) varies greatly so it is best to install the loop above or below the listener at floor or ceiling height. The loop field will not be as strong but it will be much more even and provide better results. Do not mount the loop cable behind dado rails as the loop signal will be uncomfortably strong for the hearing aid user.

Try to locate ceiling loops approximately 1.2m above the listener's head (listening height with the hearing aid user sitting or standing is normally 1.2 to 1.8m from the floor). Note that when using a ceiling mounted loop, approximately 20% of the amplifier's power will be lost for every 1.5m increase in height so the cable should never be mounted higher than 7m above listening height.

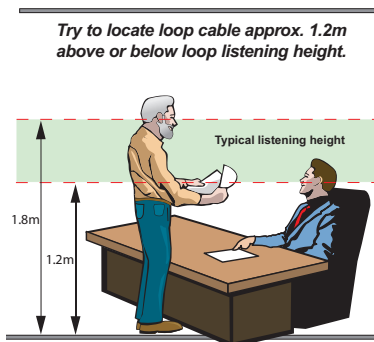

Structural steel, in particular, large sheets of metal (solid or perforated) such as metal suspended ceilings, can absorb the magnetic field resulting in uneven coverage or dead spots. To avoid the magnetic field being absorbed by structural steel, if possible keep the loop about a metre from large uprights.

If there is a steel-reinforcing grid in the floor, either put the loop in the ceiling or, if it must go in the floor, install the loop in plastic conduit as far above the grid as possible. The amplifier's drive current may have to be turned up to overcome the effects of the metal, so choose the largest conductor size possible to suit the area.

If an application has a suspended ceiling with a metal grid and non-metallic ceiling tiles, tie-wrap the loop cable to the support wires a couple of centimetres above the tiles. If the tiles are metallic, the field strength will be affected, especially if they are electrically cross-bonded although it may be possible to partially overcome this by increasing the drive control on the amplifier. If single core cable fails to provide the required field strength in such applications, consider using three core cable and choc block to create three loops in series. Although this technique increases field strength it also reduces the top-end audio frequencies making the loop sound bass heavy, however this can be redressed using the metal compensation control on the PDA Pro-Range of amplifiers or the tone control on a PDA200E.

On floor loops, avoid running the loop up and over door openings as there will be a 'dead spot' (i.e. no signal) when the hearing aid user passes through. At doors and windows, the loop cable can pass vertically up and down either side. However, this wastes some power so care should be taken if the amplifier is only just capable of covering the area. Generally, we would suggest allowing 20% extra power in the amplifier if vertical runs are needed.

In applications with flat ceilings and sloping floors (cinemas, theatres, etc), try to run the loop at the same angle as the floor, perhaps behind a non-metallic handrail (if one is available) to ensure the signal is distributed evenly throughout the building.

Always run a trial loop and test to evaluate performance by listening to the signal with either a hearing aid or a dedicated loop listening device. To ensure the system complies with BS7594 we recommend you also test the system using a pink noise generator and magnetic field strength meter.

### **Dead spots**

In the region directly above or below the loop cable, the signal will drop to zero. This is because a hearing aid's coil only responds to the vertical component of magnetic field. The higher the loop is placed, the wider the dead spot immediately over and under the cable will be.

### **Overspill**

The signal generated by the induction loop will appear outside as well as inside the loop - sometimes up to three times the loop width away. This is often referred to as 'overspill'. Similarly, a loop placed at ceiling height gives excellent coverage in the room above and a loop placed at floor level will cover the room below. Placing the downstairs loop in the floor and the upstairs loop in the ceiling will reduce the problem but if the loops are large the overspill may still be unacceptable.

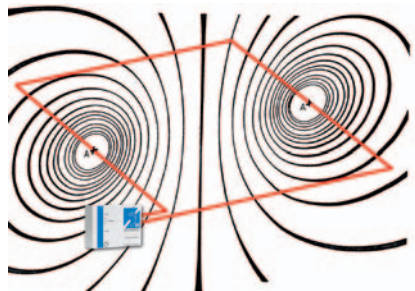

The importance of overspill depends on the application. For instance, it will probably not matter if a church service can be picked up in the church grounds. However, should the signal from one loop system interfere with another in a multi-screen cinema, or a confidential loop signal in a police station be picked up by an unauthorised person in a neighbouring room, this is more concerning. BS7594 suggests several technically complex solutions to prevent overspill that are reasonably effective but rarely employed due to high cost. In many cases overspill can be reduced nearly as effectively and for much less cost, using the special loop patterns described overleaf.

## 'Low overspill' reduced sized loops

One of the most obvious and cost-effective ways of reducing overspill is to install a reduced sized loop within the area requiring coverage. We can estimate how much overspill there will be by looking at the width of the loop (which controls the overspill). For example, if we look at the following diagram of a 4m x 6m perimeter loop you can see the signal overspills outside the room before dropping off to an inaudible level at around 12 metres.

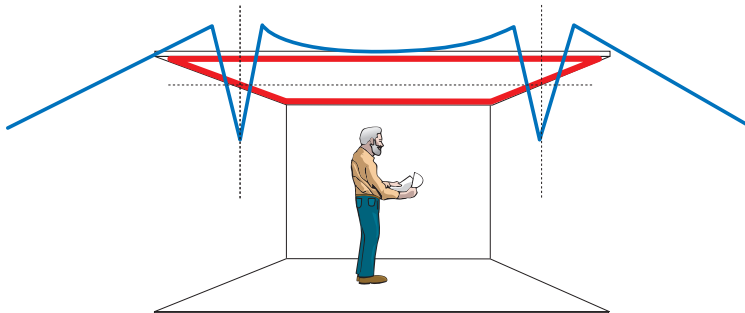

Logically, if we wanted to reduce the overspill we can move the loop into the room moving the overspill with it, thus:-

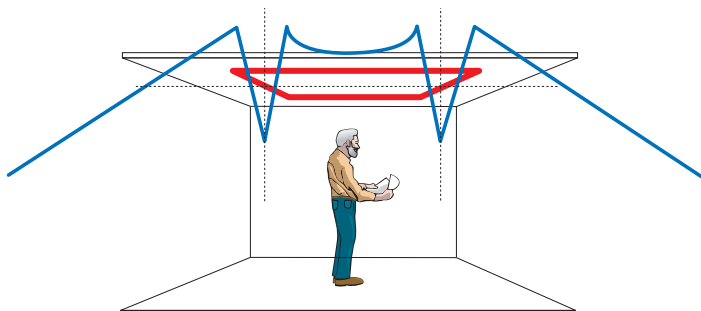

It is important to remember there will be a dead spot immediately above or below the loop cable and that anyone sitting over it won't hear anything (this is due to the fact that hearing aid coils only respond to the vertical component of the magnetic field). However, unless the loop is a long way above or below the listener, this 'dead' spot will be very narrow and it is often an acceptable compromise in return for reduced overspill. In our experience, the loss of some areas in the room to hearing aid users is accepted as a 'reasonable provision' as long as the person responsible for the room is made aware of this.

## 'Low overspill' phase-shifting loops

For applications where minimal overspill *and* consistent coverage throughout the site (i.e. no dead spots) is essential, you may wish to consider using an APSS phase shifter. This is a more costly and time-consuming method than the reduced size loop described earlier but it will avoid any deadspots being formed inside the loop. The APSS is designed to work with the Outreach Plate audio input extension system (see page 19). It works by taking the signal from one or more Outreach plates and producing two signals that are 90° out of

phase with each other. These signals are then fed into two (identical) induction loop amplifiers which are in turn connected to two induction loops laid out in a special overlapping pattern. The resultant magnetic field is evenly spread within the area being covered but the strength falls off much more quickly than normal outside the loop.

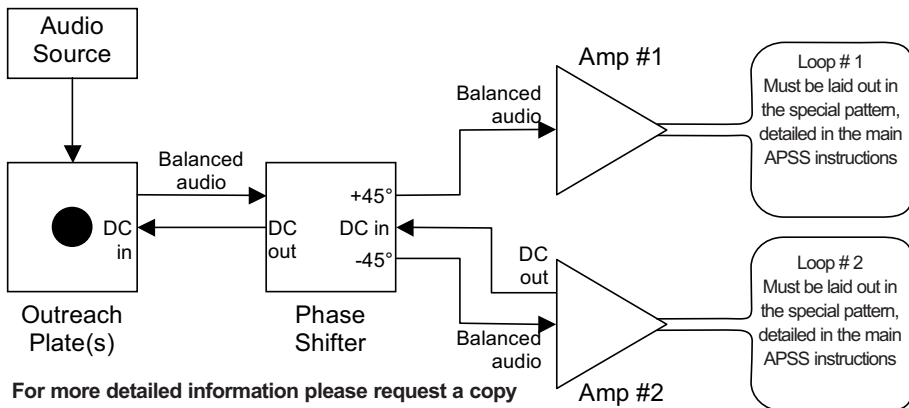

### ‘Low overspill’ fixed table loops

This pattern restricts the loop to the immediate vicinity of the table and, depending on the layout, there should be little or no overspill outside the room. The area of the loop is the overall length x the width, ignoring the shape of the pattern. The perimeter is the actual cable length and this may result in a larger cable diameter being required than for a rectangular loop.

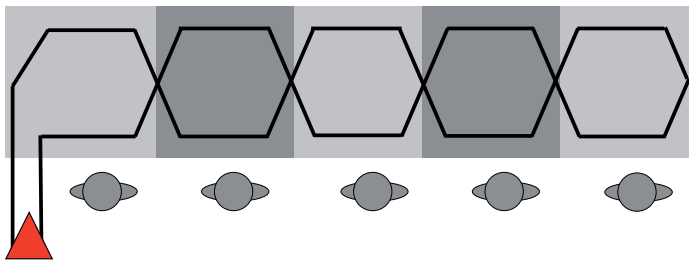

### Mains hum

Some buildings have an underlying 50Hz hum present, especially old properties where live and neutral wiring takes separate routes, resulting in a loop. However, most hearing aids are designed to reject such low frequencies, and so this is not normally a practical problem.

### Interference

Induction loops will interfere with other equipment, i.e., electric guitars will definitely pick up the magnetic field and cause feedback although some are less sensitive. If listeners can hear a hum when the loop system is operating, turn the amplifier off completely and test for noise using a hearing aid or a loop listening device. The noise should still be present and proves it cannot be due to the loop amplifier. We recommend this be tested for before installation.

## Damage to the loop

A simple break can be repaired provided it can be found. All that matters is that the join is low resistance and allows the required current to flow through the loop. If the loop cable is shorted to earth, for instance, by drilling through it and touching a reinforcing grid, the amplifier output stage will be damaged. This cannot be protected against.

## The isolation issue

When a hearing aid user switches his or her hearing aid to the 'T' position, its on-board microphone is switched off and the only noise that can be heard is the loop signal. If the system is connected to just one sound source, such as a TV, some hearing aid users say the lack of background noise makes them feel isolated. This can be overcome by positioning a microphone where it will convey background noise and pick up general conversation - this can be easily achieved using our Outreach input extension system.

## Vertical loops

Virtually all loops are laid in the horizontal (as around the skirting board). This is due to the directional response of the hearing aid (see diagram right). However, in an application such as a hospital where the hearing aid wearer is predominantly lying down then no signal will be received. It is therefore necessary to run the loop cable at an angle of 45 degrees from floor to ceiling as this will allow the hearing aid to cut across the plane and receive a signal.

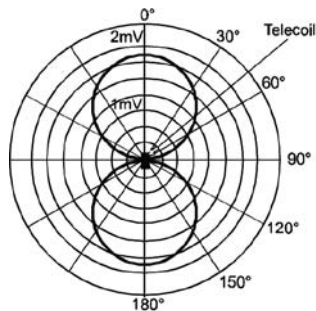

## In summary...

Each induction loop system can bring with it its own set of problems and issues.

Before designing a system, try to find answers to the following questions. Once you have the answers, the information in this guide will help you provide an effective solution.

- ▶ What is the area used for (reception, meeting room, lecture theatre, etc)?
- ▶ Do you require an audio input from a TV/Video?
- ▶ Do you require an input from an existing PA system?
- ▶ Do you require fixed or mobile microphones?
- ▶ How many microphone positions are required?
- ▶ Do any rooms next or close to the area require a separate system?
- ▶ What are the dimensions of the area - length, width and height?
- ▶ Where can the loop cable be installed - ceiling / floor void, in floor screed, under floor covering or wall?
- ▶ What is the ceiling height and how is it constructed?
- ▶ Is there any steel or other metals around the building?
- ▶ Is there any risk of theft to the equipment?
- ▶ Does it need to be a 'secure' system with little overspill?

# Testing an induction loop system

## General testing

We recommend all induction loop systems are tested using our 'FoSmeter H' loop listening device (order code AHHM/H) and a set of 32 Ohm headphones (order code HEAD1).

With all relevant audio inputs active, start by listening to the loop signal in the centre of the loop. If the signal level is not acceptable, adjust the drive control on the amplifier in small increments until it is. When you are satisfied with the signal in the centre of the loop, move around the room to ensure coverage is consistent throughout. Pay particular attention to areas where hearing aid users are likely to gather.

The 'FoSmeter H' comes with a built-in magnetic strength meter. The meter's red peak indicator (the fifth LED on the gauge) should only illuminate with peaks in the input signal - if it is lit too frequently, the audio sound quality will be distorted and the amplifier may overheat. If this is the case, try adjusting the layout of the loop and/or consider purchasing a more powerful amplifier. If it is impossible to illuminate all of the indicators on the magnetic strength meter even when the DRIVE control is turned fully clockwise, the thickness (CSA) of the induction loop cable used may be insufficient. Refer to page 21, to ensure you are using the recommended cable for the application.

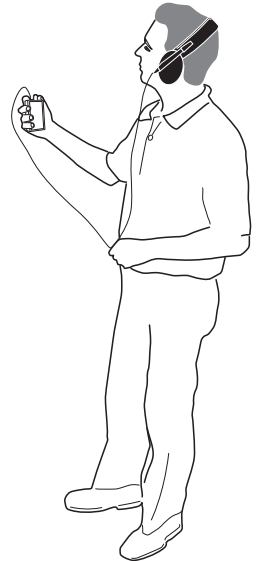

## Testing to BS7594

For compliance with BS7594 (the code of practice for audio-frequency induction loop systems), we recommend you also check the system using a pink noise generator as the system's audio source. BS7594 recommends what the magnetic field strength over a covered area should be and we believe the most efficient way of ensuring this is achieved is to measure the field strength of a steady output. Unlike music or speech (both of which provide a variable sound output from which it is virtually impossible to obtain an accurate RMS reading), pink noise has an equal and constant average amount of energy content per octave of bandwidth. When fed into loop system, pink noise therefore gives a constant field strength which can be easily and accurately measured using a magnetic field strength meter.

The following PDA range test equipment is available:-

- ▶ FoSmeter H Combined magnetic field strength meter & loop listener (part no. AHHM/H)
- ▶ FoSmeter+ Combined pink noise generator & magnetic field strength meter (part no. AMPN)
- ▶ FoSmeter Magnetic field strength meter only (part no. AHHM)
- ▶ PNGN Pink noise generator only (part no. PNGN)
- ▶ AL1 3.5mm jack (for PNGN) to 3.5mm jack lead
- ▶ AL2 3.5mm jack (for PNGN) to double phone lead
- ▶ AL3 3.5mm jack (for PNGN) to bare ended lead
- ▶ HEAD1 Headphones for use with FosMeter H

## Key features of the PDA Range of AFILS testing equipment



### PNGN

- ▶ Can be connected to the line level input of most AFILS amplifiers
- ▶ Has a fixed level output of 400V rms and a crest factor of 4:1
- ▶ Note that a selection of 10m long connection leads (AL1, AL2 and AL3 are available)
- ▶ Requires 1 x PP3 battery (not supplied)



### FOSMETER

- ▶ Accurately measures the magnetic field strength of any AFILS system
- ▶ Calibrated at manufacture for accuracy and linearity
- ▶ Includes ten LEDs laid out in 3dB increments
- ▶ Two switches - Normal/A-weight Filter and High/low Gain
- ▶ Requires 1 x PP3 battery (not supplied)



### FOSMETER H

- ▶ Combines the functions of a magnetic field strength meter and loop listening device in one unit
- ▶ Allows conventional audio signals such as music or speech to be tested for distortion using 32 Ohm headphones (part no. HEAD1)
- ▶ The unit's gain switch is set to operate in low mode only to prevent interference from mains hum when listening to the system
- ▶ Requires 1 x PP3 battery (not supplied)



### FOSMETER +

- ▶ Combines the functions of a pink noise generator and magnetic field strength meter.
- ▶ We recommend the FoSmeter + is used for testing small installations only as it is not practical to have a long lead trailing from a pink noise output socket to the AFILS amplifier.
- ▶ Requires 1 x PP3 battery (not supplied)

# Full PDA range parts listing

## PORTABLE INDUCTION LOOP KITS (approx. 1.2m<sup>2</sup> coverage)

PL1/K1	Portable induction loop kit (supplied in a cardboard storage/carry case) Includes PL1 amplifier c/w battery & integral microphone, plugtop charger and sticker.
PL1/K2	Portable induction loop kit with AFILS tester (supplied in a cardboard storage/carry case) Includes PL1 amplifier c/w battery & integral microphone, plugtop charger, sticker, AHHM/H combined FoSmeter H magnetic field strength meter/loop listener and headphones.
PL1/K3	Portable induction loop kit (supplied in a robust plastic storage/carry case) Includes PL1 amplifier c/w battery & integral microphone, plugtop charger and sticker.
PL1/K4	Portable induction loop kit with AFILS tester (supplied in a robust plastic storage/carry case) Includes PL1 amplifier c/w battery & integral microphone, plugtop charger, sticker, AHHM/H combined FoSmeter H magnetic field strength meter/loop listener and headphones.
PL1/BATT	Replacement battery for PL1 amplifier

## 1.2m<sup>2</sup> COUNTER INDUCTION LOOP KITS

ML1/K	ML1 counter induction loop kit c/w ML1 wall-mounting double gang loop amplifier, AMT mic. and TX2 counter loop
PDA102C	PDA102 counter induction loop kit c/w PDA102 free-standing loop amplifier, AMT microphone and TX121 counter loop

## 1.2m<sup>2</sup> VEHICLE INDUCTION LOOP KITS

VL1/B1	12V vehicle induction loop kit c/w VL1 mini-12V induction loop amplifier, AL8 Fused cigarette lighter to 2.5mm DC power connector, TX2 pre-formed loop, AMT microphone
VL1/B2	24V vehicle induction loop kit c/w VL1 mini-12V induction loop amplifier, AL7 2.5mm DC power connector to bare ended lead, 24V to 12V DC convertor, TX2 pre-formed loop, AMT microphone

## 50m<sup>2</sup> INDUCTION LOOP AMPLIFIERS & KITS

DL50/K	DL50 50m <sup>2</sup> Domestic induction loop amplifier kit c/w DL50 free-standing loop amplifier, AMT tie/desk mic., APS scart lead & loop cable
PDA102L	PDA102 50m <sup>2</sup> Small room loop kit (tie/desk mic version) c/w PDA102 free-standing loop amplifier, AMT tie/desk microphone and loop cable
PDA102R	PDA102 50m <sup>2</sup> Small room loop kit (omni-directional plated mic. version) c/w PDA102 free-standing loop amplifier, APM plated microphone and loop cable
PDA102S	PDA102 50m <sup>2</sup> TV lounge loop kit c/w PDA102 free-standing loop amplifier, Scart lead and APL connection plate and loop cable

## 120m<sup>2</sup> INDUCTION LOOP AMPLIFIERS & KITS

Please note: Loop cable is not included in the following 'AK' range kits. We recommend you use 1mm<sup>2</sup> single core cable such as our LOOP2/W cable which is available in 100m reels..

PDA200E	PDA200E 120m <sup>2</sup> wall-mounting induction loop amplifier
AKM1	PDA200E 120m <sup>2</sup> Meeting/seminar room loop kit c/w PDA200E amplifier, APM omni-directional mic plate
AKL1	PDA200E 120m <sup>2</sup> Lecture room loop kit c/w PDA200E amplifier, AMT tie/desk mic, AML lectern mic, 2 x APJ plate

AKT1	PDA200E 120m <sup>2</sup> TV / music lounge loop kit c/w PDA200E amplifier, AMH handheld mic, APS scart lead, APJ plate, APL plate
AKR1	PDA200E 120m <sup>2</sup> Waiting room loop kit c/w PDA200E amplifier, APL plate
AKU1	PDA200E 120m <sup>2</sup> Retail unit loop kit c/w PDA200E amplifier, AML lectern mic, APJ plate
AKW1	PDA200E 120m <sup>2</sup> Place of worship loop kit 1 c/w PDA200E amplifier, AML lectern mic, APJ plate, APL plate
AKW2/L	PDA200E 120m <sup>2</sup> Place of worship loop kit 2(lavalier mic. version) c/w PDA200E amplifier, AMR/LA lavalier radio mic, APQM plate, 2 x APXM plate
AKW2/H	PDA200E 120m <sup>2</sup> Place of worship loop kit 2 (handheld mic. version) c/w PDA200E amplifier, AMR/HA handheld radio mic, APQM plate, 2 x APXM plate
AKH1/L	PDA200E 120m <sup>2</sup> Health and fitness club loop kit (lavalier mic. version) c/w PDA200E amplifier, AMR/LA lavalier radio mic, APQM plate, APL plate
AKH1/H	PDA200E 120m <sup>2</sup> Health and fitness club loop kit (handheld mic. version) c/w PDA200E amplifier, AMR/HA handheld radio mic, APQM plate, APL plate

### **PRO-RANGE (200m<sup>2</sup> to 900m<sup>2</sup>) INDUCTION LOOP AMPLIFIERS**

PDA200/2	200m <sup>2</sup> free standing induction loop amplifier
PDA500/2	500m <sup>2</sup> free standing induction loop amplifier
PDA1000/2	900m <sup>2</sup> free standing induction loop amplifier
PDA/RM	19" rack mount kit for PDA Pro-Range amplifier
PDA/WM	Wall mount kit for PDA Pro-Range amplifier

### **OUTREACH PLATE AUDIO INPUT EXTENSION SYSTEM**

CAN BE USED TO INCREASE THE NUMBER OF AUDIO INPUTS ON AN INDUCTION LOOP SYSTEM\*

\*The ML1, PDA102, PDA200E and PDA Pro-Range amplifiers all have Outreach connection sockets. A separate 12V PSU may be required when connecting outreach plates to other amplifiers. Plates should be wired using Belden 8723 audio cable.

APJ	3.5mm mono jack plate, for connection of AMT, AMH, AML or AMD microphones
APL	Line level audio plate, for connection of APS SCART lead/other line level audio feeds
APQM	6.35mm stereo jack plate, for connection of AMR/L &AMR/H radio microphone kit
APQL	6.35mm stereo jack plate, for connection of line level feeds from mixing desks, etc
APXM	XLR mic level plate, for connection of AMP microphone
APXL	XLR line level plate, for connection of line level feeds from mixing desks, etc
APM	Omni-directional plated microphone, for wall/ceiling/desk mounting
API	AFILS active indicator light
APS	SCART to double phono lead (for use with APL plate)

### **PDA RANGE MICROPHONES**

APM	Omni-directional plated microphone, for wall/ceiling/desk mounting For direct connection to ML1, DL50, VL1, PDA102, PDA200E, PDA Pro-Range or an outreach chain
AMT	Tie/desk microphone for ML1, DL50, VL1, PDA102, PDA200E, PL1, PDA Pro-Range or APJ plate
AMH	Handheld microphone for ML1, DL50, VL1, PDA102, PDA200E, PL1, PDA Pro-Range or APJ plate
AML	Lectern microphone for ML1, DL50, VL1, PDA102, PDA200E, PL1, PDA Pro-Range or APJ plate
AMLS	Lectern microphone (short stemmed version of AML)

AMD	Desktop microphone for ML1, DL50, VL1, PDA102, PDA200E, PL1, PDA Pro-Range or APJ plate
AMDS	Desktop microphone (short stemmed version of AMD)
AMP	Professional handheld mic. for PDA200E or APXM outreach plate, requires AXLR lead
AMR/LA	Lavalier radio mic. (173.8 KHz) c/w Rx, Tx, psu. for PDA200E or APQM outreach plate
AMR/LB	Lavalier radio mic. (174.6 KHz) c/w Rx, Tx, psu. for PDA200E or APQM outreach plate
AMR/LC	Lavalier radio mic. (175.0 KHz) c/w Rx, Tx, psu. for PDA200E or APQM outreach plate
AMR/HA	Handheld radio mic. (173.8 KHz) c/w Rx, Tx, psu. for PDA200E or APQM outreach plate
AMR/HB	Handheld radio mic. (174.6 KHz) c/w Rx, Tx, psu. for PDA200E or APQM outreach plate
AMR/HC	Handheld radio mic. (175.0 KHz) c/w Rx, Tx, psu. for PDA200E or APQM outreach plate
PRO45	Hanging ambient microphone for PDAPro-Range or APXM plate

## **INDUCTION LOOP TEST EQUIPMENT**

RXTI2	Induction loop test receiver requires 2 x AAA batteries & walkman type headphones
PNGN	Pink noise generator requires 1 x PP3 battery and AL1, AL2 or AL3 connection lead
AHHM	FoSmeter magnetic field strength meter - requires 1 x PP3 battery
AMPN	FoSmeter+ combined pink noise generator & magnetic field strength meter requires 1 x PP3 battery and AL1, AL2 or AL3 connection lead
AHHM/H	FoSmeter H combined magnetic field strength meter & loop listener requires 1 x PP3 battery & 32 Ohm headphones such as our HEAD1 headphones
HEAD1	32 Ohm headphones for use with AHHM/H
AL1	3.5mm jack to 3.5mm jack lead (connects PNGN to APJ outreach plate)
AL2	3.5mm jack to double phono lead (connects PNGN to APL outreach plate or DL50)
AL3	3.5mm jack to pre-cut bare ended lead

Loop cable is included in all ML1/K, VL1/B1, VL1/B2 DL50/K and PDA102 range induction loop kits. For PDA200E & AK Range kits we recommend LOOP2/W cable. For other PDA range loop amplifiers, call our technical dept. for advice.

## **INDUCTION LOOP CABLE & MISCELLANEOUS OTHER AFILS ANCILLARIES**

LOOP1/W	100m x 0.5mm <sup>2</sup> single core white loop cable (for black cable order LOOP1/B)
LOOP2/W	100m x 1.0mm <sup>2</sup> single core white loop cable (for black cable order LOOP2/B)
LOOP3/W	100m x 1.5mm <sup>2</sup> single core white loop cable (for black cable order LOOP3/B)
LOOP4/W	100m x 2.5mm <sup>2</sup> single corewhite loop cable (for black cable order LOOP4/B)
FLAT1005	100m x 0.5mm <sup>2</sup> insulated copper tape (flat loop cable for under carpets)
FLAT2005	100m x 1.0 mm <sup>2</sup> insulated copper tape (flat loop cable for under carpets)
FLAT3005	100m x 1.5mm <sup>2</sup> insulated copper tape (flat loop cable for under carpets)
TAPE	50m white synthetic fibre tape (used to protect flat loop cable)
BELDEN/10	10m Belden 8723 four core screened cable for use with outreach plates
BELDEN/25	25m Belden 8723 four corescreened cable for use with outreach plates
APT	Loop connector plate (for the termination of induction loop cable)
AXLR	XLRto XLRLlead (used to connect AMPmic to APXM outreach plate)
LEST	100V line (i.e PA system output) to 0db (775mV line level) convertor
APPS	Overspill reduction phase shifter
TEAR10	Pack of 10 self-adhesive 'induction loop fitted' stickers



**Distributed by**



CIE-Group Ltd Widdowson Close Blenheim Ind Est  
Bulwell Nottingham NG6 8WB

**T +44(0)115 9770075 F +44(0)115 9770081**  
**E info@cie-group.com W www.cie-group.com**

Registered in England No. 2761780



Approved Document No. DCP0003535 Rev 0. E&OE. No responsibility can be accepted by the manufacturer or distributors of the PDA Range of audio frequency induction loop equipment for any misinterpretation of an instruction or guidance note or for the compliance of the system as a whole.